

F50CT2 Series

50W single output with c.c circuit and PFC function



- **Constant current design(C.C. mode)**
- Built-in PFC function
- Protections: Over current / Short circuit
- IP68 design for outdoor installations
- 100% full load burn-in test
- 3 in 1 dimming function(option : D type)
- Suitable for LED lighting and street lighting applications
- Safety standards : K61347-1, K61347-2-13
- EMC standards : K61547
- Metal case

UPF50S20CT2

Blank : IP68 rated. Cable for I/O connection.

Output voltage and current level can be adjusted through internal potentiometer

D(option) : IP68 rated. Constant current level adjustable through output cable with 10V PWM signal or 1-10Vdc or resistance

IP68 SELV

ITEM		UPF50S20CT2
INPUT	VOLTAGE RANGE	AC180~264V
	FREQUENCY RANGE	47~63Hz
	POWER FACTOR	PF>0.95
	THD(max.)	20%(@Dimming 1V~10V)
	EFFICIENCY(typ.)	91%
	AC CURRENT(typ.)	0.21A/230VAC (typ)
	INRUSH CURRENT(typ.)	COLD START 5A/230VAC
	LEAKAGE CURRENT	<2.5mA / 230VAC
OUTPUT	RATED CURRENT	2.1A
	CONSTANT CURRENT REGION	17-20V
	RATED POWER	42W
	CURRENT ADJ. RANGE	0.4~2.4A
	CURRENT ACCURACY	±5%
	RIPPLE&NOISE(max.) Note2	1.5Vp-p
	SETUP,RISE TIME(max.)	3000ms,200ms/230VAC at full load
PROTEC-TION	OVER CURRENT Note3	95~108%
	SHORT CIRCUIT	Hiccup mode ; recovers automatically after fault condition is removed
ISOLA-TION	WITHSTAND VOLTAGE	I/P-O/P:AC3KV, I/P-F.G:AC1.5KV, O/P-F.G:AC0.5KV
	ISOLATION RESISTANCE	I/P-O/P, I/P-F.G, O/P-F.G:DC500V 100Mohms(At room temp. & humid.)
ENVIRON-MENT	WORKING TEMP.&HUMID.	-40~+70°C(Refer to "DERATING CURVE),20~95%RH
	STORAGE TEMP.&HUMID.	-40~+80°C,10~95%RH
	VIBRATION	10~500Hz, 5G 12min./1cycle, period for 72min. each along X, Y, Z axes
OTHERS	DIMENSION/WEIGHT	192*55.5*37.3mm(L*W*H)/0.6Kg

NOTE

1. All parameters not specially mentioned are measured at 220vac input, rated load and 25°C of ambient temperature.
2. Ripple & noise are measured at 20MHz of bandwidth by using a 12" twisted pare-wire terminated with 0.1 uF & 47uF parallel capacitor.
3. Refer to "DRIVING METHODS of LED MODULE"

S.M.P.S

LED Converter

Water Proof Converter

■ BLOCK DIAGRAM

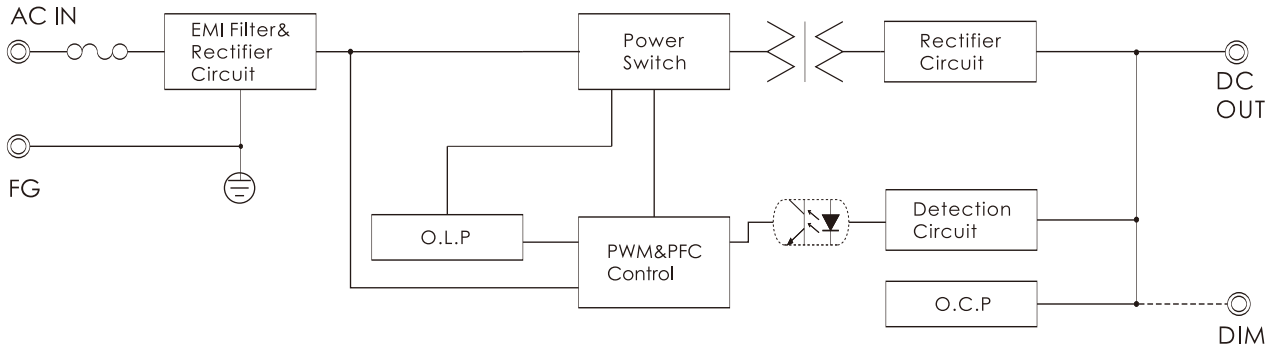

■ DIMENSIONS(unit:mm)

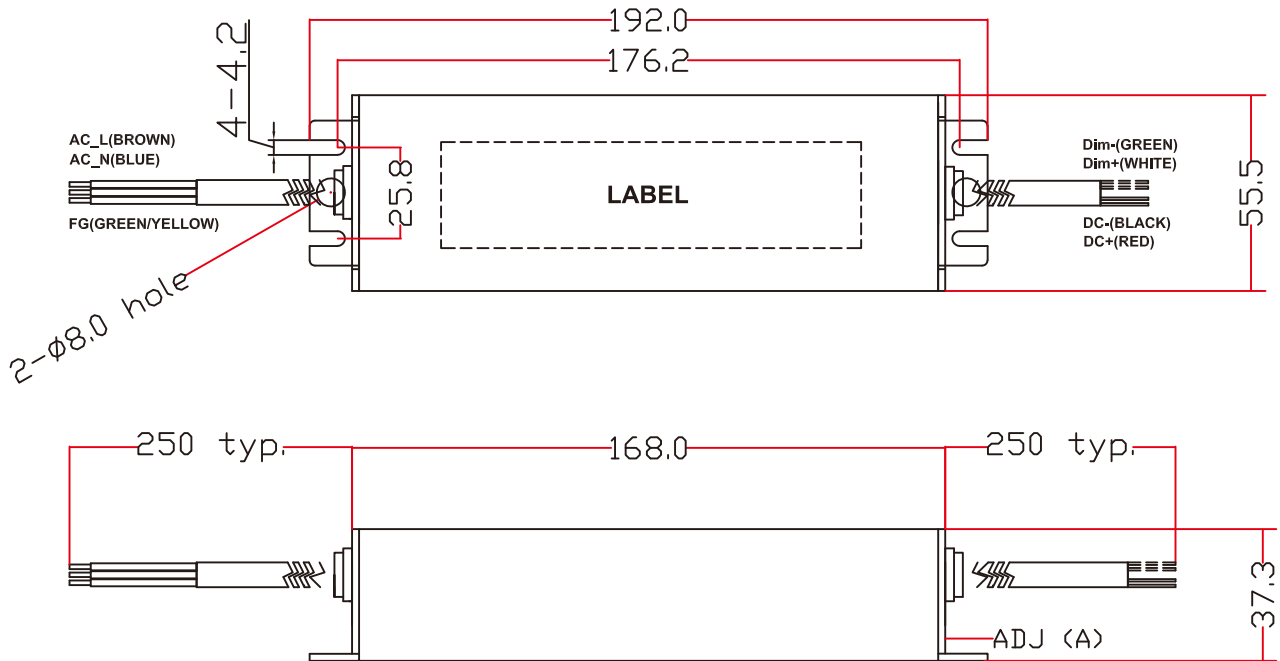

■ DERATING CURVE

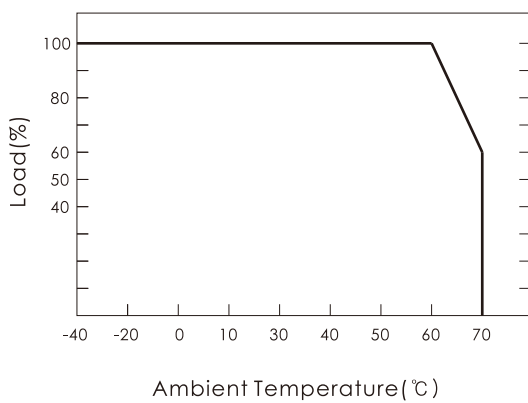

■ STATIC CHARACTERISTICS

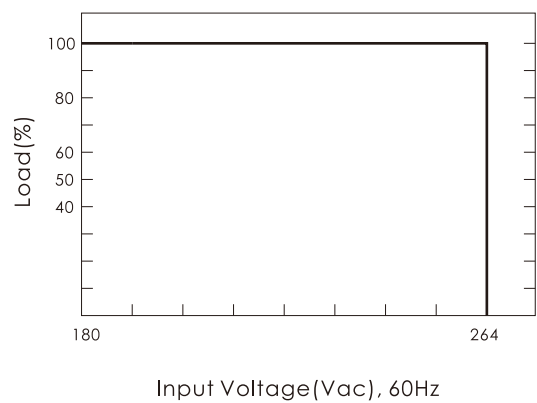

■ DIMMING OPERATION

- Built-in 3 in 1 dimming function.
Output constant current level can be adjusted through output cable by connecting 10V PWM signal or 1-10Vdc or resistance between DIM+ and DIM-.

- Please do not connect 'DIM-' to 'V-'

- 10V PWM signal for output current adjustment (typ.):
frequency range: 100Hz~3KHz

Duty Value	10%	20%	30%	40%	50%	60%	70%	80%	90%	100%	Open
Percent of Rated Current	5~20%	15~25%	25~35%	35~45%	45~55%	55~65%	65~75%	75~85%	85~95%	95~105%	95~108%

- 1-10V dimming function for output current adjustment (typ.)

Dimming Value	1V	2V	3V	4V	5V	6V	7V	8V	9V	10V	Open
Percent of Rated Current	5~20%	15~25%	25~35%	35~45%	45~55%	55~65%	65~75%	75~85%	85~95%	95~105%	95~108%

- Reference resistance value for output current adjustment (typ.)

Resistance Value	Single driver	10KΩ	20KΩ	30KΩ	40KΩ	50KΩ	60KΩ	70KΩ	80KΩ	90KΩ	100KΩ	Open
	Multiple driver (N=driver quantity for synchronized dimming operation)	10KΩ /N	20KΩ /N	30KΩ /N	40KΩ /N	50KΩ /N	60KΩ /N	70KΩ /N	80KΩ /N	90KΩ /N	100KΩ /N	---
Percent of Rated Current		5~20%	15~25%	25~35%	35~45%	45~55%	55~65%	65~75%	75~85%	85~95%	95~105%	95~108%